

1011.0100 - PORTAPUNZONE REGOLABILE

ADJUSTABLE PUNCH HOLDER / VERSTELLBARE STEMPELHALTEPLATTEN / PORTE-POINÇON RÉGLABLE

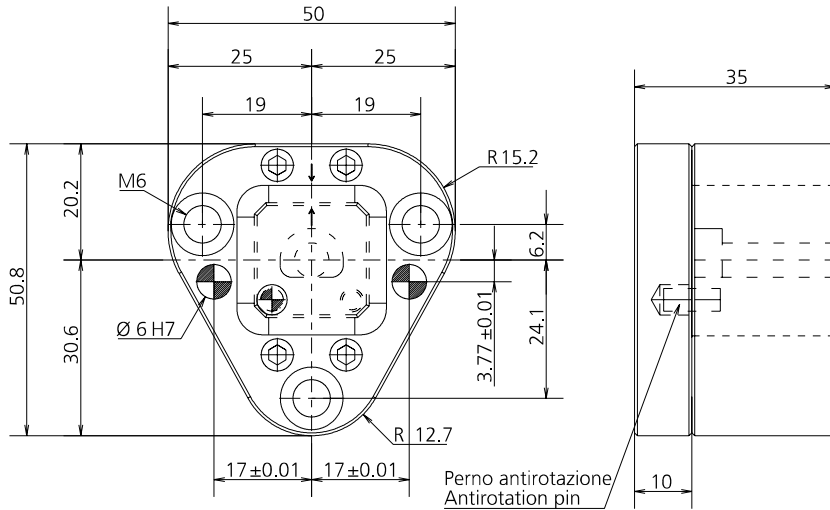

CODE	DESCRIPTION
1011.0100	ADJUSTABLE PUNCH HOLDER

CODE	PUNCH	Q.TY
1071.0105	ISO8020 Ø5	1*CHOOSE
1071.0106	ISO8020 Ø6	1*CHOOSE
1071.0108	ISO8020 Ø8	1*CHOOSE

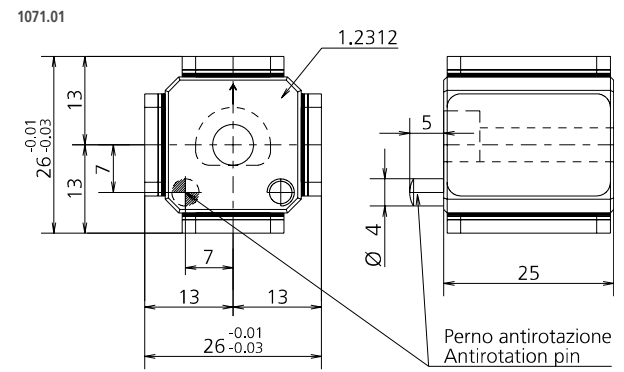

MODELLO D'ORDINE / ORDER EXAMPLE / BESTELLBEISPIEL / MODÈLE DE COMMANDE

MODEL **1011.0100** OPTION CODE **1071.0105**