

0140.0320 - CAM M320

FORZA INIZIALE DI ESTRAZIONE / INITIAL EXTRACTION FORCE **70 daN**
 RÜCKZUGSKRAFT / FORCE INITIALE D'EXTRACTION
 FORZA FINALE DI ESTRAZIONE / FINAL FORCE OF EXTRACTION **320 daN**
 ENDKRAFT DER EXTRACTION / FORCE FINALE D'EXTRACTION

SFORZO MAX TRANCIO **5000 daN**
 CUTTING MAX FORCE
 MAXIMALE SCHNITTKRAFT
 EFFORT MAXI DÉCOUPE

* MAX 30% LUNGHEZZA LIBERA

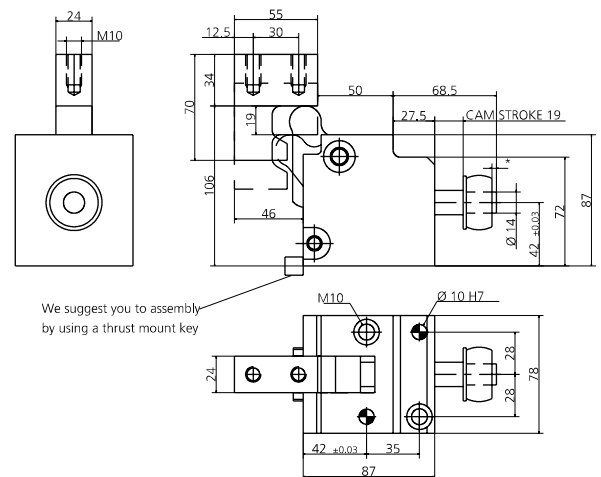
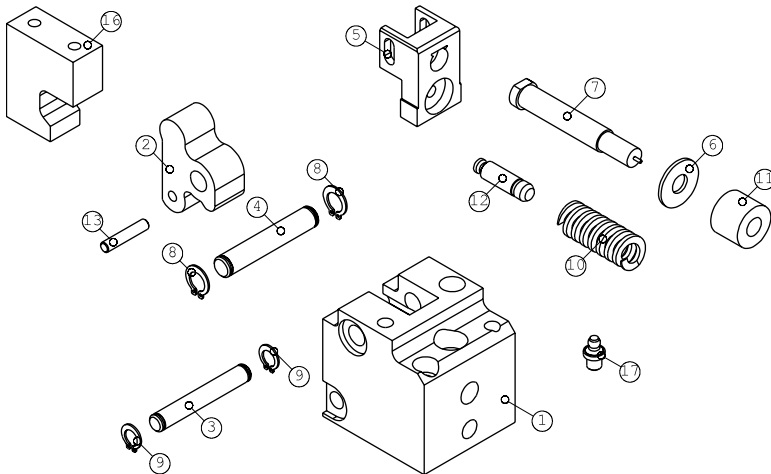

POS.	CODE	DESCRIPTION	Q.TY
001	8000.0040.0320	CORPO CAMMA / CAM BODY / GRUNDGEHÄUSE	1
002	8001.4041.0320.000	LEVA / LEVER / NOCKE 0	1
002	8001.4041.0320.620	LEVA / LEVER / NOCKE +0.01 +20	1*OPTION
002	8001.4041.0320.640	LEVA / LEVER / NOCKE +20.01 +40	1*OPTION
002	8001.4041.0320.720	LEVA / LEVER / NOCKE -0.01 -20	1*OPTION
002	8001.4041.0320.740	LEVA / LEVER / NOCKE -20.01 -40	1*OPTION
003	8005.0780.0740.100.001	PERNO / PIN / STIFT	1
004	8005.0780.0740.120.001	PERNO / PIN / STIFT	1
005	8014.4041.0320	PORTA PUNZONE / GATE PUNCH / STEMPELHALTEPLATTE	1
006	8006.0020.0350.141.001	RONDELLA / WASHER / UNTERLEGSCHIBE	1
007	09MJBM2.160.096	MJB_PUNZONE TC CON ESPULSORE / HEADED PUNCH WITH EJECTOR / SCHNEIDSTEMPEL MIT ABSTOSSER 16 96.5	1
007	09MJXM2.160.096	MIX_PUNZONE TC CON ESPULSORE / HEADED PUNCH WITH EJECTOR / SCHNEIDSTEMPEL MIT ABSTOSSER 16 96.5	1*OPTION
007	09MJOM2.160.096	MJO_PUNZONE TC CON ESPULSORE / HEADED PUNCH WITH EJECTOR / SCHNEIDSTEMPEL MIT ABSTOSSER 16 96.5	1*OPTION
007	09MJJM2.160.096	MJJ_PUNZONE TC CON ESPULSORE / HEADED PUNCH WITH EJECTOR / SCHNEIDSTEMPEL MIT ABSTOSSER 16 96.5	1*OPTION
007	09MJHM2.160.096	MJH_PUNZONE TC CON ESPULSORE / HEADED PUNCH WITH EJECTOR / SCHNEIDSTEMPEL MIT ABSTOSSER 16 96.5	1*OPTION
007	09MJKM2.160.096	MJK_PUNZONE TC CON ESPULSORE / HEADED PUNCH WITH EJECTOR / SCHNEIDSTEMPEL MIT ABSTOSSER 16 96.5	1*OPTION
007	09MJNM2.160.096	MJN_PUNZONE TC CON ESPULSORE / HEADED PUNCH WITH EJECTOR / SCHNEIDSTEMPEL MIT ABSTOSSER 16 96.5	1*OPTION
007	09MJLM2.160.096	MJL_PUNZONE TC CON ESPULSORE / HEADED PUNCH WITH EJECTOR / SCHNEIDSTEMPEL MIT ABSTOSSER 16 96.5	1*OPTION
007	09MJRM2.160.096	MJR_PUNZONE TC CON ESPULSORE / HEADED PUNCH WITH EJECTOR / SCHNEIDSTEMPEL MIT ABSTOSSER 16 96.5	1*OPTION
007	09MJVM2.160.096	MJV_PUNZONE TC CON ESPULSORE / HEADED PUNCH WITH EJECTOR / SCHNEIDSTEMPEL MIT ABSTOSSER 16 96.5	1*OPTION
007	09MJYM2.160.096	MJY_PUNZONE TC CON ESPULSORE / HEADED PUNCH WITH EJECTOR / SCHNEIDSTEMPEL MIT ABSTOSSER 16 96.5	1*OPTION
007	09MJZM2.160.096	MJZ_PUNZONE TC CON ESPULSORE / HEADED PUNCH WITH EJECTOR / SCHNEIDSTEMPEL MIT ABSTOSSER 16 96.5	1*OPTION
008	9004.1120.001	SEEGER / SEEGER / SEEGERRING	2
009	9004.1100.001	SEEGER / SEEGER / SEEGERRING	2
010	9009.2000.0640.250	MOLLA / SPRING / FEDER	1
011	8060.1432.020.E090.001	MOLLA IN GOMMA / RUBBER SPRING / ABSTREIFFEDER	1
012	8005.0465.0300.120.001	PERNO / PIN / STIFT	1
013	8005.0350.0350.080.001	PERNO / PIN / STIFT	1
016	8003.0700.0550.240.001	INCLUDINE / ANVIL / TREIBER	1*OPTION
017	9006.002	INGRASSATORE / NIPPLE / SCHMIERUNG	1

002 (8001) LEVA / LEVER / NOCKE

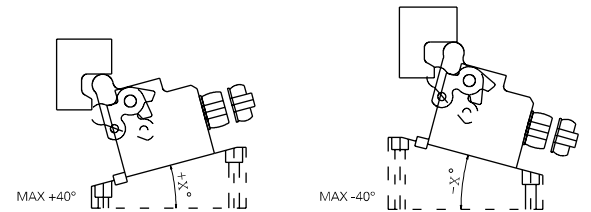

8124.0140.0320 KIT ADATTAMENTO STARK STRIPPER / STARK-STRIP ADAPTION KIT / STARK-STRIP ADAPTIONSSATZ

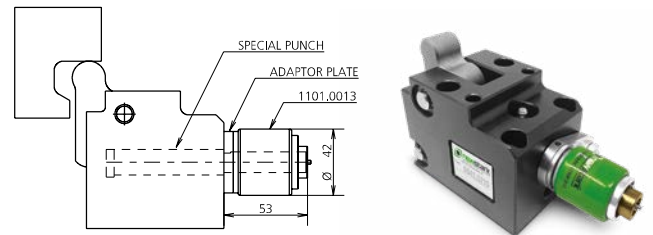

Il kit comprende il punzone, la piastrina di adattamento e le viti di fissaggio.
 Lo stark-stripper va ordinato a parte (vedi la sezione del catalogo dedicata)
 The kit includes the punch, the adaptor plate and the fixing screws.
 The stark-stripper must be ordered separately (see the dedicated catalog section)
 Das Kit enthält den Stempel, die Adapterplatte und die Befestigungsschrauben.
 Der Stark-muss separat bestellt werden (siehe den entsprechenden Abschnitt des Katalogs)

007 (09M) PUNZONE TC / HEADED PUNCH / SCHNEIDSTEMPEL ISO8020

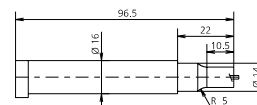

007 (09S) PUNZONE SPECIALE PER KIT 8124 / SPECIAL PUNCH FOR KIT 8124 / SPEZIALSTEMPEL FÜR BAUSATZ 8124

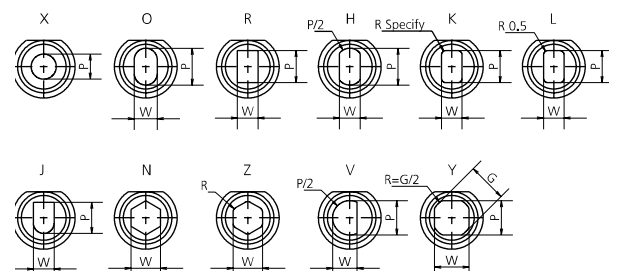
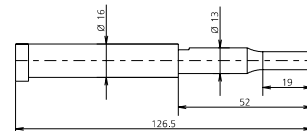

MODELLO D'ORDINE / ORDER EXAMPLE / BESTELLBEISPIEL / MODÈLE DE COMMANDE

MODEL **0140.0320** INCLINATION **+10°** OPTION CODE **8001.4041.0320.620**