

FORZA INIZIALE DI ESTRAZIONE / INITIAL EXTRACTION FORCE **505 daN**
 RÜCKZUGSKRAFT / FORCE INITIALE D'EXTRACTION
 FORZA FINALE DI ESTRAZIONE / FINAL FORCE OF EXTRACTION **1110 daN**
 ENDKRAFT DER EXTRAKTION / FORCE FINALE D'EXTRACTION

SFORZO MAX TRANCIO **4500 daN**
 CUTTING MAX FORCE
 MAXIMALE SCHNITTKRAFT
 EFFORT MAXI DÉCOUPE

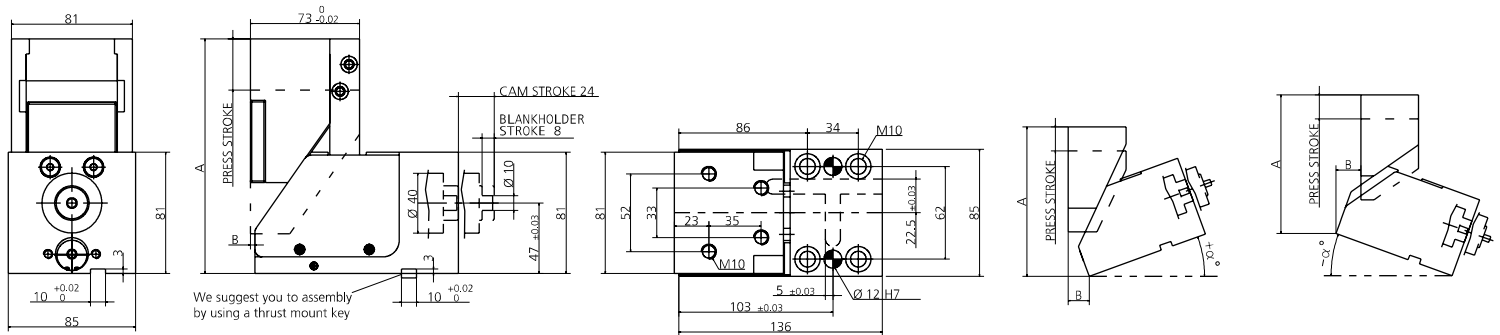

α°	PRESS STROKE	A	B
0°	34.1	156.67	2.99
+5°	32.05	162.19	8.51
+10°	29.6	163.55	16.62
+15°	26.9	166	23.69
-5°	30.6	153.75	0.99
-10°	27.8	144.67	8.01
-15°	25.65	136.67	14.01

* PER INCLINAZIONI FUORI STANDARD RIVOLGERSI ALL'UFFICIO TECNICONEWSTARK / * FOR NON-STANDARD INCLINATIONS, PLEASE CONTACT NEWSTARK TECHNICAL OFFICE.
 /* FÜR NICHT STANDARDMÄSSIGE NEIGUNGEN WENDEN SIE SICH BITTE AN DAS TECHNISCHE BÜRO VON NEWSTARK

0011 (9090) PUNZONE SBOZZATO / BLANK PUNCH / ROHLING SCHNEIDSTEMPEL ISO8020

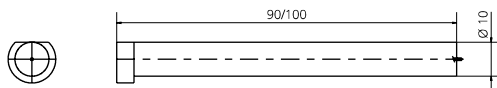

013 (9016) PREMILAMIERA SBOZZATO / BLANK-BLANKHOLDER / ROHLING BLECHHALTER

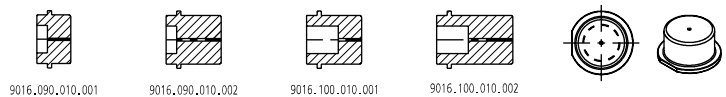

011 (093J_) PUNZONE SAGOMATO / SHAPED PUNCH / GEFORMT SCHNEIDSTEMPEL ISO8020

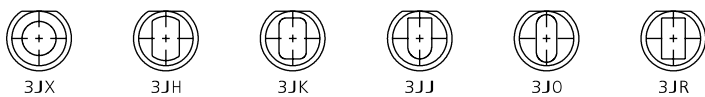

013 (8016) PREMILAMIERA SAGOMATO / SHAPED BLANKHOLDER / GEFORMT BLECHHALTER (OPTION)

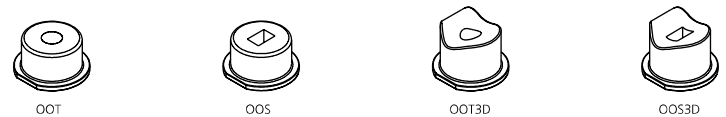

015 (9003) SENSORE / SENSOR / SENSOR



15 PATENT PENDING

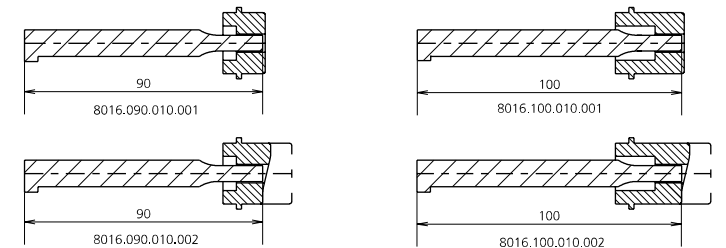

0147.5050 - CAM MASE505-10

FORZA INIZIALE DI ESTRAZIONE / INITIAL EXTRACTION FORCE **505 daN**
 RÜCKZUGSKRAFT / FORCE INITIALE D'EXTRACTION
 FORZA FINALE DI ESTRAZIONE / FINAL FORCE OF EXTRACTION **1110 daN**
 ENDKRAFT DER EXTRACTION / FORCE FINALE D'EXTRACTION

SFORZO MAX TRANCIO **4500 daN**
 CUTTING MAX FORCE
 MAXIMALE SCHNITTKRAFT
 EFFORT MAXI DÉCOUPE

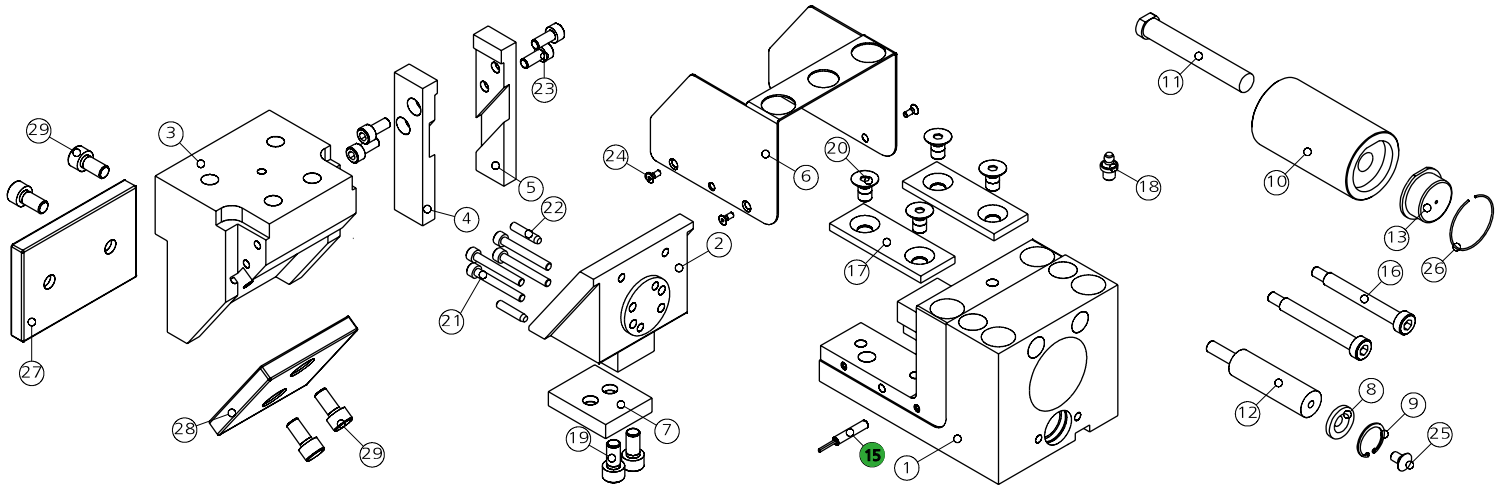

POS.	CODE	DESCRIPTION	Q.TY
001	8000.0047.0505	CORPO CAMMA / CAM BODY / GRUNDGEHÄUSE	1
002	8111.0047.0005.00.001	SLITTA / SLIDER / LAGERKEIL 0°	1*CHOOSE
002	8111.0047.0005.05.001	SLITTA / SLIDER / LAGERKEIL +5°	1*CHOOSE
002	8111.0047.0005.10.001	SLITTA / SLIDER / LAGERKEIL +10°	1*CHOOSE
002	8111.0047.0005.15.001	SLITTA / SLIDER / LAGERKEIL +15°	1*CHOOSE
003	8116.0047.0005.00.001	CUNEO / WEDGE / DRUCKSTÜCK 0°	1*CHOOSE
003	8116.0047.0005.05.001	CUNEO / WEDGE / DRUCKSTÜCK -5°	1*CHOOSE
003	8116.0047.0005.10.001	CUNEO / WEDGE / DRUCKSTÜCK -10°	1*CHOOSE
003	8116.0047.0005.15.001	CUNEO / WEDGE / DRUCKSTÜCK -15°	1*CHOOSE
004	8115.0047.0005.00.001	STAFFA DI AGGANCIAMENTO / BRACKET ATTACHMENTS / BRACKETBEFESTIGUNG 0°	1*CHOOSE
004	8115.0047.0005.05.001	STAFFA DI AGGANCIAMENTO / BRACKET ATTACHMENTS / BRACKETBEFESTIGUNG -5°	1*CHOOSE
004	8115.0047.0005.10.001	STAFFA DI AGGANCIAMENTO / BRACKET ATTACHMENTS / BRACKETBEFESTIGUNG -10°	1*CHOOSE
004	8115.0047.0005.15.001	STAFFA DI AGGANCIAMENTO / BRACKET ATTACHMENTS / BRACKETBEFESTIGUNG -15°	1*CHOOSE
005	8115.0047.0005.00.002	STAFFA DI AGGANCIAMENTO / BRACKET ATTACHMENTS / BRACKETBEFESTIGUNG 0°	1*CHOOSE
005	8115.0047.0005.05.002	STAFFA DI AGGANCIAMENTO / BRACKET ATTACHMENTS / BRACKETBEFESTIGUNG -5°	1*CHOOSE
005	8115.0047.0005.10.002	STAFFA DI AGGANCIAMENTO / BRACKET ATTACHMENTS / BRACKETBEFESTIGUNG -10°	1*CHOOSE
005	8115.0047.0005.15.002	STAFFA DI AGGANCIAMENTO / BRACKET ATTACHMENTS / BRACKETBEFESTIGUNG -15°	1*CHOOSE
006	8010.0047.0505	COPERCHIO / COVER / KOPFPLATTE	1
007	8011.0047.0505	PIASTRA / PLATE / PLATTE	1
008	8006.0130.0218.065.001	RONDELLA / WASHER / UNTERLEGSCHIBE	1
009	9004.2220.001	SEEGER / SEEGER / SEEGERRING	1
010	9030.010.001	CILINDRO SPECIALE / SPECIAL CYLINDER / SPEZIALZYLINDER	1
011	9090.3JBM2.100.090	PUNZONE SBOZZATO TC CON ESPULSORE / HEADED PUNCH WITH EJECTOR / SCHNEIDSTEMPEL MIT ABSTOSSER 10 90	1*OPTION
011	9090.3JBM2.100.100	PUNZONE SBOZZATO TC CON ESPULSORE / HEADED PUNCH WITH EJECTOR / SCHNEIDSTEMPEL MIT ABSTOSSER 10 100	1*OPTION
011	093J_M2.100.090	PUNZONE TC CON ESPULSORE / HEADED PUNCH WITH EJECTOR / SCHNEIDSTEMPEL MIT ABSTOSSER 10 90	1*OPTION

POS.	CODE	DESCRIPTION	Q.TY
011	093J_M2.100.100	PUNZONE TC CON ESPULSORE / HEADED PUNCH WITH EJECTOR / SCHNEIDSTEMPEL MIT ABSTOSSER 10 100	1*OPTION
012	9000.0025.0019.004	CILINDRO DI RITORNO / RETURN CYLINDER / RÜCK ZYLINDER	1
013	9016.090.010.001	PREMILAMIERA CORTO / SHORT BLANKHOLDER / KURZ BLECHHALTER 90MM	1*CHOOSE
013	9016.090.010.002	PREMILAMIERA LUNGO / LONG BLANKHOLDER / LANG BLECHHALTER 90MM	1*CHOOSE
013	9016.100.010.001	PREMILAMIERA CORTO / SHORT BLANKHOLDER / KURZ BLECHHALTER 100MM	1*CHOOSE
013	9016.100.010.002	PREMILAMIERA LUNGO / LONG BLANKHOLDER / LANG BLECHHALTER 100MM	1*CHOOSE
013	8016.090.010.001	PREMILAMIERA CORTO / SHORT BLANKHOLDER / KURZ BLECHHALTER 90MM	1*OPTION
013	8016.090.010.002	PREMILAMIERA LUNGO / LONG BLANKHOLDER / LANG BLECHHALTER 90MM	1*OPTION
013	8016.100.010.001	PREMILAMIERA CORTO / SHORT BLANKHOLDER / KURZ BLECHHALTER 100MM	1*OPTION
013	8016.100.010.002	PREMILAMIERA LUNGO / LONG BLANKHOLDER / LANG BLECHHALTER 100MM	1*OPTION
015	9003.0001	SENSORE DI SICUREZZA / SECURITY SENSOR / SENSOR FÜR SICHERHEIT	1*OPTION
016	9008.0608.055	VITE A COLLETO / SHOULDER SCREW / ANSATZSCHRAUBE	2
017	8012.0700.0280.050.001	PIASTRA DI SCORRIMENTO / WEAR PLATE / DRUCKPLATTE	2
018	9006.002	INGRASSATORE / NIPPLES / SCHMIERUNG	1
019	9007.06.010.088.1.9327	VITE / SCREW / SCHRAUBE M6X10	2
020	9007.08.010.129.1.5933	VITE / SCREW / SCHRAUBE M8X10	4
021	9007.04.020.129.1.4762	VITE / SCREW / SCHRAUBE M4X20	4
022	9028.04.010.8735	SPINA CILINDRICA / DOWEL PIN / ZYLINDERSTIFT D4X10	2
023	9007.06.012.129.1.4762	VITE / SCREW / SCHRAUBE M6X12	4
024	9007.03.005.048.1.7687	VITE / SCREW / SCHRAUBE M3X5	4
025	9007.06.014.129.1.5933	VITE / SCREW / SCHRAUBE M6X14	1
026	9004.2290.001	SEEGER / SEEGER / SEEGERRING	1
027	8012.0810.0550.100.001	PIASTRA DI SCORRIMENTO / WEAR PLATE / DRUCKPLATTE	1
028	8012.0650.0600.100.001	PIASTRA DI SCORRIMENTO / WEAR PLATE / DRUCKPLATTE	1
029	9007.08.016.109.1.9327	VITE / SCREW / SCHRAUBE M8X16	4