

FORZA INIZIALE DI ESTRAZIONE / INITIAL EXTRACTION FORCE **1160 daN** SFORZO MAX TRANCIO **9000 daN**
 RÜCKZUGSKRAFT / FORCE INITIALE D'EXTRACTION
 FORZA FINALE DI ESTRAZIONE / FINAL FORCE OF EXTRACTION **2550 daN** CUTTING MAX FORCE
 ENDKRAFT DER EXTRACTION / FORCE FINALE D'EXTRACTION MAXIMALE SCHNITTKRAFT
 EFFORT MAXI DÉCOUPE

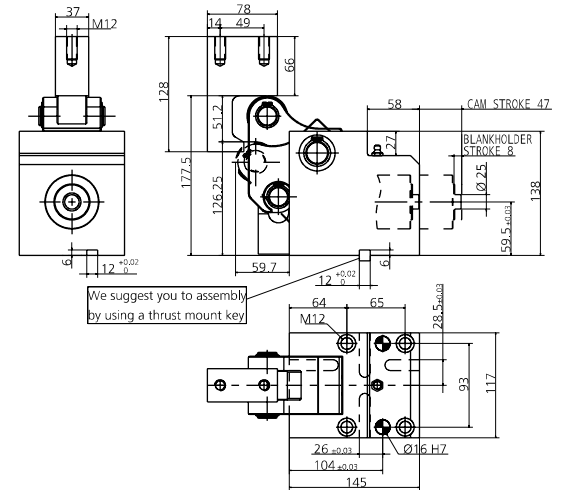

POS.	CODE	DESCRIPTION	Q.TY
001	8000.0043.1160	CORPO CAMMA / CAM BODY / GRUNDGEHÄUSE	1
002	8001.0043.1160.000	LEVA / LEVER / NOCKE 0	1
002	8001.0043.1160.610	LEVA / LEVER / NOCKE +0.01 +10	1*OPTION
002	8001.0043.1160.620	LEVA / LEVER / NOCKE +10.01 +20	1*OPTION
002	8001.0043.1160.630	LEVA / LEVER / NOCKE +20.01 +30	1*OPTION
002	8001.0043.1160.640	LEVA / LEVER / NOCKE +30.01 +40	1*OPTION
002	8001.0043.1160.710	LEVA / LEVER / NOCKE -0.01 -10	1*OPTION
002	8001.0043.1160.720	LEVA / LEVER / NOCKE -10.01 -20	1*OPTION
002	8001.0043.1160.730	LEVA / LEVER / NOCKE -20.01 -30	1*OPTION
002	8001.0043.1160.740	LEVA / LEVER / NOCKE -30.01 -40	1*OPTION
002	8001.0043.1160.750	LEVA / LEVER / NOCKE -40.01 -50	1*OPTION
003	8002.0043.1160	FLANGIA / FLANGE / FLANSCH	1
004	8003.1280.0780.370.001	INCUDINE / ANVIL / DRUCKSTÜCK	1*OPTION
005	8004.0450.0330.220.001	ROTELLA / ROLLER / ROLLE	1
006	8005.1164.1078.250.001	PERNO / PIN / STIFT	1
007	8005.0734.0648.220.001	PERNO / PIN / STIFT	1
008	8005.0644.0558.220.001	PERNO / PIN / STIFT	1
009	9030.025.001	CILINDRO SPECIALE / SPECIAL CYLINDER / SPEZIALZYLINDER	1
010	9090.3JBM2.250.090	PUNZONE TC CON ESPULSORE / HEADED PUNCH WITH EJECTOR / SCHNEIDSTEMPEL MIT ABSTOSSER 25 90	1*OPTION
010	9090.3JBM2.250.100	PUNZONE TC CON ESPULSORE / HEADED PUNCH WITH EJECTOR / SCHNEIDSTEMPEL MIT ABSTOSSER 25 100	1*OPTION
010	093J_M2.250.090	PUNZONE TC CON ESPULSORE / HEADED PUNCH WITH EJECTOR / SCHNEIDSTEMPEL MIT ABSTOSSER 25 90	1*OPTION
010	093J_M2.250.100	PUNZONE TC CON ESPULSORE / HEADED PUNCH WITH EJECTOR / SCHNEIDSTEMPEL MIT ABSTOSSER 25 100	1*OPTION
011	9000.0050.0019.001	CILINDRO DI RITORNO / RETURN CYLINDER / RÜCK ZYLINDER	1
012	9016.090.205.001	PREMILAMIERA CORTO / SHORT BLANKHOLDER / KURZ BLECHHALTER 90MM	1*CHOOSE
012	9016.090.205.002	PREMILAMIERA LUNGO / LONG BLANKHOLDER / LANG BLECHHALTER 90MM	1*CHOOSE
012	9016.100.205.001	PREMILAMIERA CORTO / SHORT BLANKHOLDER / KURZ BLECHHALTER 100MM	1*CHOOSE
012	9016.100.205.002	PREMILAMIERA LUNGO / LONG BLANKHOLDER / LANG BLECHHALTER 100MM	1*CHOOSE
012	8016.090.205.001	PREMILAMIERA CORTO / SHORT BLANKHOLDER / KURZ BLECHHALTER 90MM	1*OPTION
012	8016.090.205.002	PREMILAMIERA LUNGO / LONG BLANKHOLDER / LANG BLECHHALTER 90MM	1*OPTION
012	8016.100.205.001	PREMILAMIERA CORTO / SHORT BLANKHOLDER / KURZ BLECHHALTER 100MM	1*OPTION
012	8016.100.205.002	PREMILAMIERA LUNGO / LONG BLANKHOLDER / LANG BLECHHALTER 100MM	1*OPTION
013	8107.0143.1165.001	KIT SENSORE DI SICUREZZA / SECURITY SENSOR KIT / KIT SENSOR FÜR SICHERHEIT	1*OPTION
014	9004.1220.001	SEEGER / SEEGER / SEEGERRING	2
015	9004.1250.001	SEEGER / SEEGER / SEEGERRING	2
016	9004.1220.001	SEEGER / SEEGER / SEEGERRING	2
017	9005.0120.0025.001	CUSCINETTO / BEARING / LAGER	2
018	9006.003	INGRASSATORE / NIPPLE / SCHMIERUNG	1
019	9004.2220.001	SEEGER / SEEGER / SEEGERRING	1
020	8006.0130.0218.065.001	RONDELLA / WASHER / UNTERLEGSCHIBE	1
022	9007.06.035.129.1.4762	VITE / SCREW / SCHRAUBE M6X35	4
023	9028.060.020.8735	SPINA CILINDRICA / DOWEL PIN / ZYLINDERSTIFT D6X20	2
025	9007.06.014.129.1.5933	VITE / SCREW / SCHRAUBE M6X14	1
026	9004.2480.001	SEEGER / SEEGER / SEEGERRING	1

002 (8001) LEVA / LEVER / NOCKE

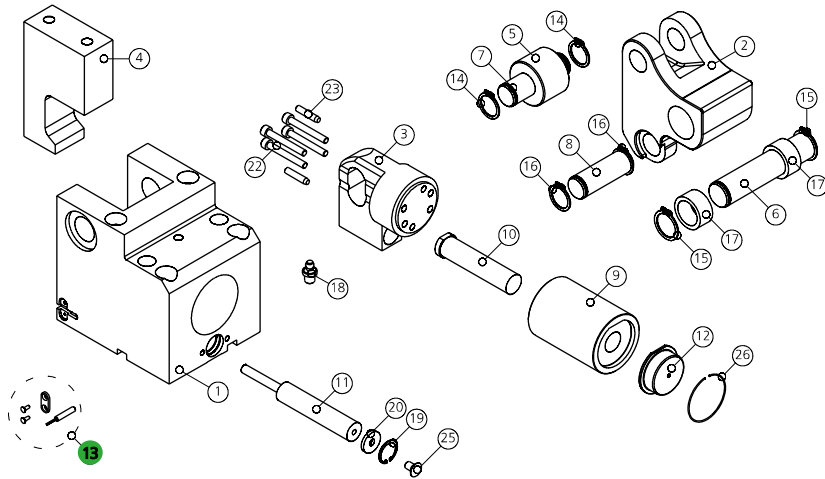
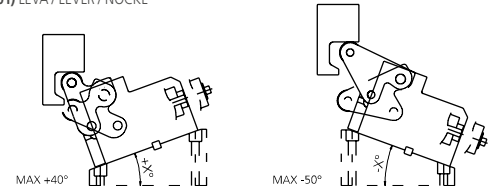

010 (9090) PUNZONE SBOZZATO / BLANK PUNCH / ROHLING SCHNEIDSTEMPEL ISO8020

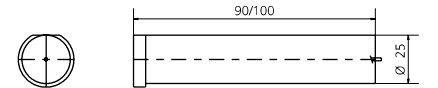

010 (093J_) PUNZONE SAGOMATO / SHAPED PUNCH / GEFORMT SCHNEIDSTEMPEL ISO8020

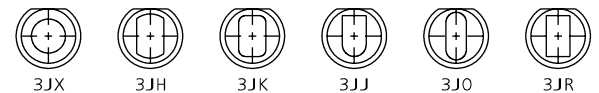

012 (9016) PREMILAMIERA SBOZZATO / BLANK-BLANKHOLDER / ROHLING BLECHHALTER

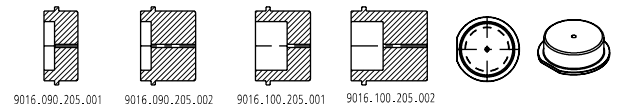

012 (8016) PREMILAMIERA SAGOMATO / SHAPED BLANKHOLDER / GEFORMT BLECHHALTER

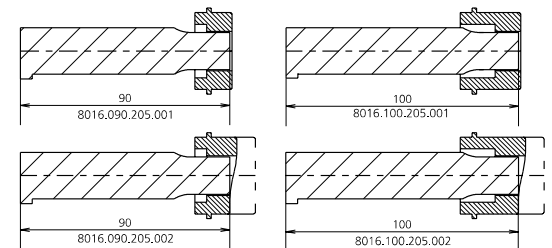

013 (8107) SENSORE / SENSOR / SENSOR



13 PATENT PENDING

MODELLO D'ORDINE / ORDER EXAMPLE / BESTELLBEISPIEL / MODÈLE DE COMMANDE

MODEL **0143.1165** INCLINATION **+10°** BLANKHOLDER **9016/8016.** OPTION CODE **8001.0043.1160.610**